

PRIME FIRE 590

WITH FRAME & GLASS PANELS *(for Room Divider, Tunnel and Island housings)*

Net Zero automatic burner with the BEV Technology®

NEW FRAME WITH GLASS PANELS

The new frame with integrated glass panels serves as a protective and aesthetic mantle for a fireplace burner, creating an embodiment of safety and elegance. Designed to cater for multiple arrangement styles, it enables tunnel, room divider, and island configurations, fostering a diversity of interior design possibilities.



AUTOMATIC REFILLING SYSTEM

The automatic pump communicates with the device, delivering the necessary amount of fuel. There is no risk of overfilling the tank or spilling the fuel.

OPTIONAL DECORATIVE TRAY

Decorative tray with ceramic logs or white stones installed on the burner, behind the fireline.



AUTOMATIC BEV® BURNER

The automatic burner with the patented BEV Technology® is the most advanced product in the industry ensuring the cleanest burning process without any smoke, smell or ash.

The flame is produced by combusting ethanol vapours and has no direct contact with the liquid fuel.

REMOTE CONTROL

Control the fire with the included remote, app on your smartphone or home automation system.



BEST BUILD QUALITY

The product passed extensive tests carried out by the leading certification institutes. It is manufactured according to UL standards and is O-TL certified, meeting the most demanding safety and quality requirements.

Prime Fire 590

(BEV Technology®)

Fuel tank capacity	3.1 L
Maximum burn time	5 hours
Maximum heat output	3.1 kW
Minimum room cubature	31 m ³
Flame height regulation	2 stages
Weight	19.9 kg
Fuel type	bioethanol 95 - 96,6%
Flue	not required
Air change rate	1 space volume per hour
Power supply	230 V
Finish	black powder coating
Materials	steel, galvanized steel, toughened glass
Application	for indoor use only

CONTROL OPTIONS



included

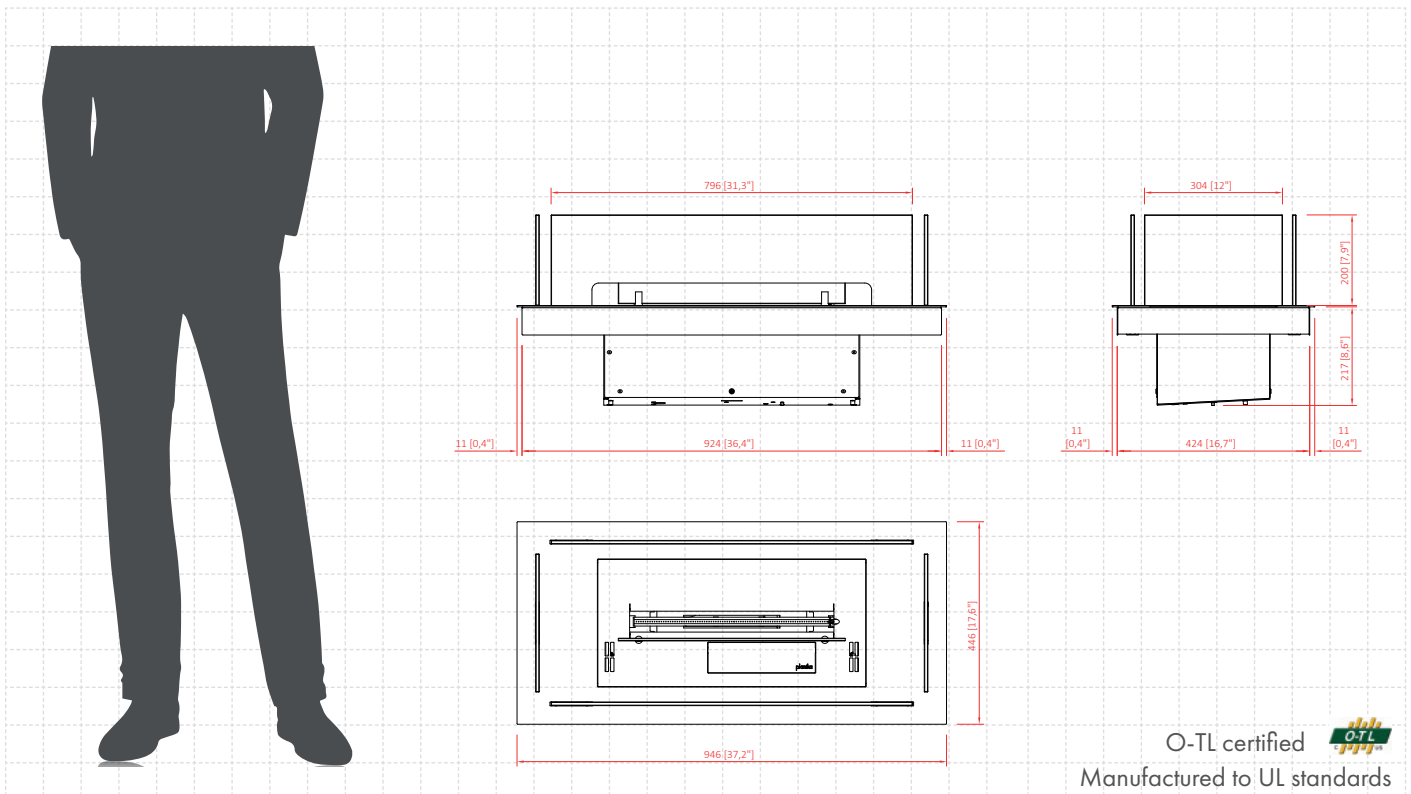

O-TL certified 
Manufactured to UL standards

All product specifications and data are subject to change without notice and are believed to be accurate as of the date hereof. Planika Sp. z o.o., its affiliates, agents, and employees, and all persons acting on its or their behalf (collectively, "Planika Sp. z o.o."), disclaim any and all liability for any errors, inaccuracies or incompleteness contained in any document or in any other disclosure relating to any product. To the maximum extent permitted by applicable law, Planika Sp. z o.o. disclaims any and all liability arising out of the application or use of any product. This document does not expand or otherwise modify Planika Sp. z o.o.'s terms and conditions of purchase, including but not limited to the warranty expressed therein. No license, express or implied, by estoppel or otherwise, to any intellectual property rights is granted by this document or by any conduct of Planika Sp. z o.o.. Customers using or selling Planika Sp. z o.o.'s products not expressly indicated for use in such applications do so entirely at their own risk and agree to fully indemnify Planika Sp. z o.o. for any damages arising or resulting from such use or sale. The images are indicative only.