

NEO 1000 BURNER

AUTOMATIC BEV[®] BURNER

Net Zero fireplace with BEV Technology[®]

AUTOMATIC BURNER

The automatic burner with the patented BEV Technology[®] is the most advanced product in the industry ensuring the cleanest burning process without any smoke, smell or ash. The flame is produced by combusting ethanol vapours and has no direct contact with the liquid fuel. Additionally, the burner is decorated with glass foam granulate.



AUTOMATIC REFILLING SYSTEM

The automatic pump communicates with the device, delivering the necessary amount of fuel. There is no risk of overfilling the tank or spilling the fuel.

REMOTE CONTROL

Take full control over the fireplace with the intuitive and minimalistic remote in your hand.

INTEGRATED CONTROL PANEL

The burner has an intuitive control panel and inlet for automatic refuelling.

FLAME CONTROL

Have control over the fire. Choose ECO mode for smaller, ambient flame or increase the height to experience the full beauty of fire.

SAFETY SENSORS

- Heat/temperature sensor
- Fuel spillage sensor
- Fuel level sensor

Neo 1000 Burner

Fuel tank capacity	3.9 L
Maximum burn time	7.0 hours
Maximum heat output	5.0 kW
Minimum room cubature	50 m ³
Flame height regulation	2 stages
Weight	18.5 kg
Fuel type	bioethanol 95 - 96,6%
Flue	not required
Air change rate	1 space volume per hour
Power supply	230 V
Finish	black powder coating
Materials	steel, galvanized steel, toughened glass
Application	for indoor use only

CONTROL OPTIONS



included

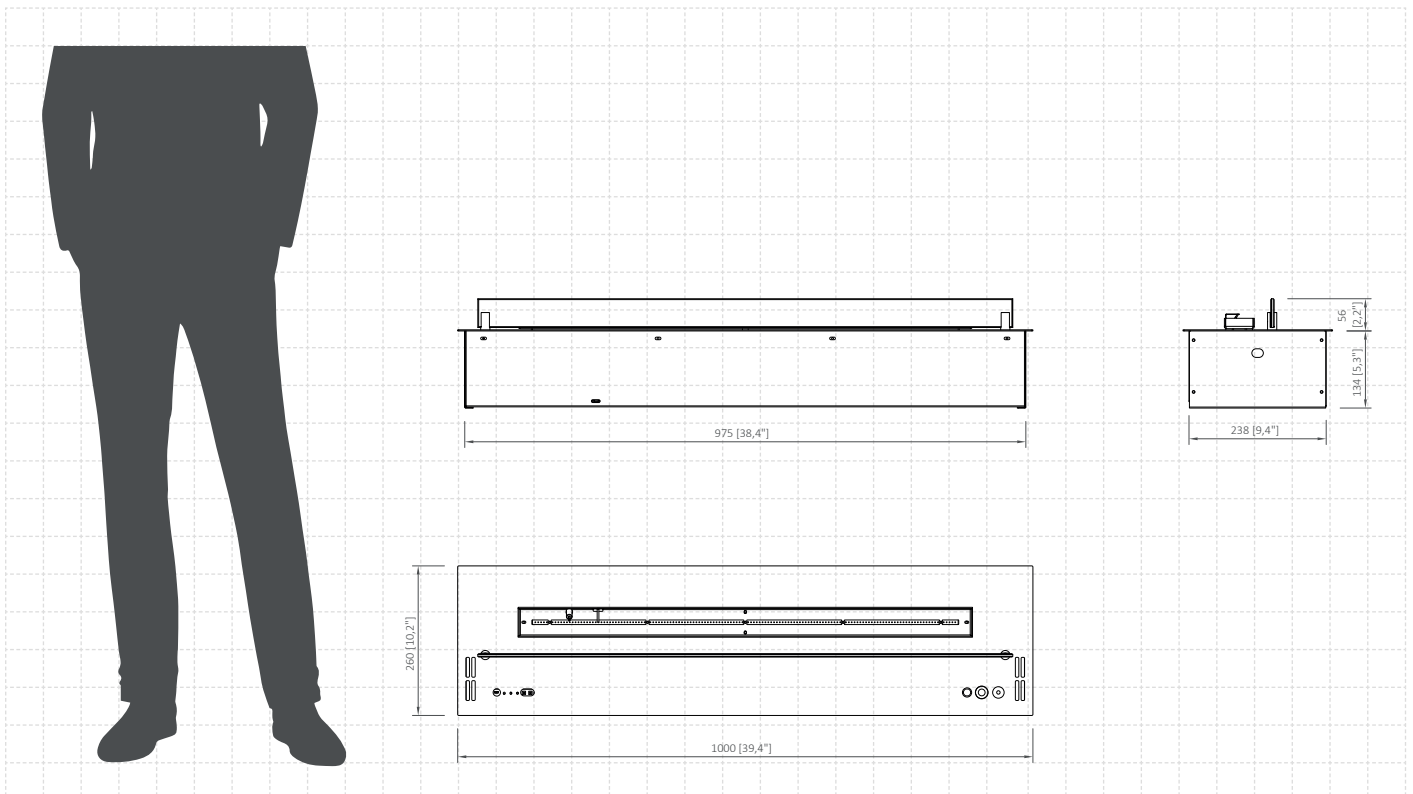

All product specifications and data are subject to change without notice and are believed to be accurate as of the date hereof. Planika Sp. z o.o., its affiliates, agents, and employees, and all persons acting on its or their behalf (collectively, "Planika Sp. z o.o."), disclaim any and all liability for any errors, inaccuracies or incompleteness contained in any document or in any other disclosure relating to any product. To the maximum extent permitted by applicable law, Planika Sp. z o.o. disclaims any and all liability arising out of the application or use of any product. This document does not expand or otherwise modify Planika Sp. z o.o.'s terms and conditions of purchase, including but not limited to the warranty expressed therein. No license, express or implied, by estoppel or otherwise, to any intellectual property rights is granted by this document or by any conduct of Planika Sp. z o.o.. Customers using or selling Planika Sp. z o.o.'s products not expressly indicated for use in such applications do so entirely at their own risk and agree to fully indemnify Planika Sp. z o.o. for any damages arising or resulting from such use or sale. The images are indicative only.